

MECH 416

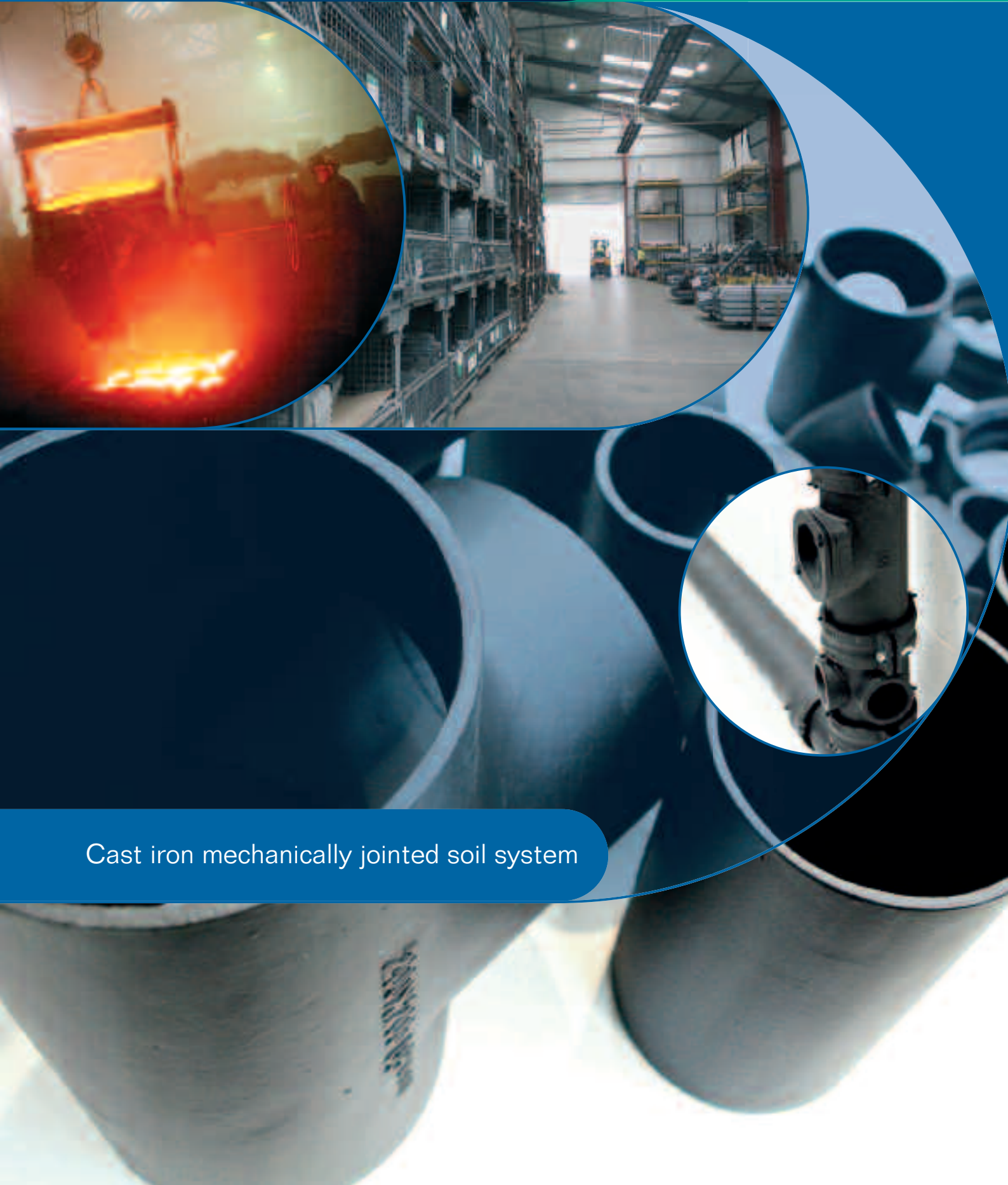

Hargreaves

RAINWATER • SOIL • DRAINAGE



Cast iron mechanically jointed soil system

Title	Page
Introduction	3
Standards	4
Benefits	5
Couplings	7
Support Brackets	8
Pipes & Couplings	9
Bends	10
Branches	11
Access Pipes & Offsets	13
Boss Pipes	13
Other Fittings	14
Brackets & Sundries	15

Hargreaves Drainage have made every effort to ensure that the information contained in this publication is, to the best of our knowledge, accurate at the time of print. The company does not accept responsibility for any errors within this literature. The company strives to continuously improve its' products and therefore reserves the right to change, without prior notice, any of the data contained in this publication.

The dimensions shown in this catalogue are accurate but subject to slight variance due to the manufacturing process.

Any orders placed from this document are subject to our standards Terms & Conditions.

Details are available on request.

Copyright © 2014 Hargreaves Drainage. All rights reserved. Any unauthorised copying or re-production will constitute an infringement of copyright.



Hargreaves Drainage's business is based on friendly, flexible and prompt service. We distribute through merchants to customers throughout the UK and Ireland. We also have the capability to distribute worldwide.

Hargreaves Drainage's UK operations and production are on one site. We have our own pattern making, foundry and fabrication facilities, which enables us to manufacture bespoke and special items to meet your requirements. Our dedicated team will manage your order throughout each stage of the process, ensuring quality standards and delivery deadlines are met in full.

We have invested significantly in warehousing and stock so that we can deliver complete orders on time and within deadlines agreed by customers.

Our technical sales staff are able to visit your site or office and can provide advice, information and quotes to specifiers, contractors and end users.

Our sales office is open between 7:30 am and 5:00 pm Monday to Friday. All telephone calls are answered promptly and personally.



The **Mech 416** system from Hargreaves Drainage is a mechanically jointed socketless cast iron system for above ground soil drainage. It is finished in a matt black two part epoxy coating.

These products are manufactured to meet the needs of specifiers and contractors. The **Mech 416** system is especially suitable for the refurbishment of apartment blocks and multi-storey car parks.

Mechanically jointed systems provide all the benefits of a conventional BS416 socket and spigot cast iron soil system but also offer significant labour savings due to the efficient jointing techniques employed.

The installation is mechanically jointed using simple and reliable couplings. It can be fitted both horizontally and vertically.



Applicable Standards

BS 416 part 2

Soil, waste and ventilating pipes and fittings.

BS 6087

Flexible joints for BS 416 part 2.

Codes of Practice

BS EN 12056

Codes of practice for gravity drainage systems, internal buildings- sanitary pipework and drainage of roofs.

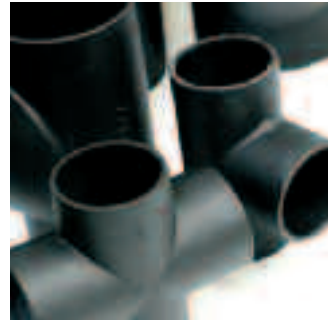

Materials

Pipes and fittings are manufactured in grey cast iron which exceeds the requirements of BS EN 1561 Grade EN-JL 1020, ISO 185 Grade 15.

Mech 416 ductile cast iron couplings are manufactured in accordance with BS EN 1563, ISO 1083 with minimum tensile strength of 420N/mm²

All couplings are supplied with EPDM rubber sealing rings which are suitable for most applications but where aggressive waste liquids are to be discharged please check with our technical departments as to their suitability. Nitrile rubber will be considered upon request.

Coating specification

Pipes

External: Two part epoxy coating (black) with an average dry wall thickness of 70 microns.

Internal: Two part epoxy coating (yellow ochre) with an average dry wall thickness of 130 microns.

Fittings

External: Two part epoxy coating (black) with an average dry wall thickness of 70 microns.

Internal: Two part epoxy coating (black) with an average dry wall thickness of 70 microns.





The Benefits of Cast Iron

Cast iron is suited to rainwater and soil drainage systems.

It offers many benefits to the customer and the contractor which include:

- **Strength and durability** - cast iron is able to withstand the rigours of on-site handling, mechanical de-blocking and vandalism.
- **Long life** - when correctly installed cast iron drainage systems will last the life of the building, whether domestic, public, industrial or commercial.
- **Low maintenance** - cast iron requires little ongoing maintenance, annual inspections are recommended but remedial action is rarely required.
- **Design capability** - cast iron can meet the needs of restoration, refurbishment, conservation and heritage work as well as new, bespoke and unique designs.
- **Sustainability** - in addition to lasting the life of a building and requiring minimal maintenance cast iron is 100% recyclable.
- **Cost effective** - owing to its longevity, low maintenance, fire resistance, and low noise operation the cost benefits of cast iron are significant.
- **Fire resistance & Safety** - the melting point of cast iron is considerably higher than PVCu or PE and in the event of a fire will not emit toxic fumes or drop burning globules of material from one compartment to another. In multi occupancy buildings intumescent fire collars need to be fitted to PVCu pipework, cast iron has no such requirement.

The Benefits of the Mech 416 Range

Comprehensive range

Mech 416 complies with BS 416 part 2 except 70mm diameter* and provides a complete system of pipes and fittings for the conveyance of waste water and rainwater through a building as far as the drain connection.

Couplings

The Mech 416 ductile cast iron two piece coupling provides a quick and efficient jointing method and is supplied in a matt black colour to match the pipework.

Lightweight

Compared to traditional BS 416 socket and spigot soil products the Mech 416 system is lighter and easier to handle but still retains all the inherent qualities of cast iron including strength and longevity.

Value for money

The Mech 416 system compares favourably with other materials; including PVCu solvent weld systems, on labour rates. It can also provide cost savings when intumescent fire collars, sound insulation, expansion joints and extra brackets are required for PVCu to satisfy the building requirements. Also, in normal circumstances, cast iron will last the life of the building.

Low maintenance

The combination of great strength and improved surface coatings on the Mech 416 system delivers a fit and forget solution in most installations. This is especially important when pipework is concealed and inaccessible and where maintenance would be disruptive to occupants of the building.

Low noise operation

A factor often overlooked is the excessive noise created by waste water running through pipework manufactured from materials with a much lower density than cast iron. Whilst never welcome, this is especially inappropriate for hospitals, hotels and apartment blocks.

Improved pipe coating

The Mech 416 system pipes are lined internally with a two part epoxy finish which provides improved performance when exposed to aggressive substances. Fittings are also epoxy coated and provide a similar level of performance.

100% recyclable and sustainable

Cast iron will not only last the life of the building but is strong enough to withstand on site handling, mechanical unblocking and vandalism. It also reduces the use of natural resources by utilising almost 100% scrap and recycled metal in the manufacturing process. Finally, when a building reaches the end of its lifespan, all the cast iron can be recycled to make new products.

*The 70mm size complies with BS416 part 2 material specification but differs slightly to traditional 75mm (3") with a marginally reduced pipe diameter. Where there is a requirement for connection of 70mm to existing 75mm pipework please contact our Sales Office who will advise on the best method and solution.

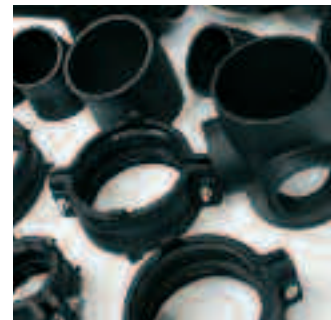



Features of the Ductile Iron Coupling

- Two piece coupling manufactured from ductile iron BS EN 1563
- Zinc plated socket cap locking screw and nut M8 x 40 for 50mm-100mm and M8 x 55 for 150mm (6mm Allen drive)
- 2 locking screws on 50mm-100mm and 4 locking screws on 150mm diameter
- EPDM sealing ring
- For use up to and including 0.5 bar internal pressure



1



2



3



4

Joining Method for Ductile Iron Couplings

Step 1

Check the components- 2 part coupling and EPDM gasket, 2 x M8 bolts and nuts for 50mm - 100mm diameter, 4 x M8 nuts and bolts for 150mm diameter.

Step 2

Fit the gasket to the lower pipe first, line up the upper pipe and fit carefully into place. Make sure the two pipes are square and parallel and line up correctly with the gasket.

Step 3

Line up the two parts of the coupling ensuring they fit correctly over the gasket.

Step 4

Bolt the two parts of the coupling together and gradually tighten. Avoid tightening only one side at a time and ensure an equal distance is maintained during assembly. Do not over tighten; the optimum torque setting is 1.5Nm.

If couplings with electrical continuity are required these are available with grub screws fitted which when tightened provide this feature.

1 The Mech 416 Bismat Bracket

Can be used for vertical and horizontal operations for pipe sizes 50mm-150mm diameter. Supplied zinc plated and rubber lined only.

This patented bracket features:

- Unique automatic locking system
- Captivated combi slot locking screw
- M8/M10 tapped bosses on 50mm-100mm sizes
- M10 tapped boss on 150mm size
- Ageing resistant EPDM rubber lining

2 The Mech 416 Heavy Duty Bossed Bracket

Available in a zinc plated finish unlined as standard for pipe sizes 50mm-150mm diameter. Also available rubber lined.

This bracket features:

- 2 x M8 locking screws on sizes 50mm-100mm
- 2 x M10 locking screws on sizes 150mm
- M8/M10 tapped boss on size 50mm
- M10/M12 tapped boss on sizes 70mm-150mm
- Can be fixed both horizontally and vertically

**3** The Mech 416 Galvanised Steel Pipe Clamp

Two part clamp: one side hinged the other side with locking screw. For pipe sizes 50mm-150mm diameter.

This clamp features:

- Specially developed for cast iron drainage pipe
- Hinged
- Hot dipped galvanised
- Resistance welded connecting nut M10 on all sizes
- Can be fixed both vertically and horizontally

4 The Mech 416 Split Band Clip

Two part band, zinc plated as standard, supplied with locking nuts and bolts for pipe sizes 50mm-150mm diameter.

This bracket features:

- Zinc plated as standard
- Can be fixed both vertically and horizontally
- Supplied complete with nuts and bolts

pipes & couplings

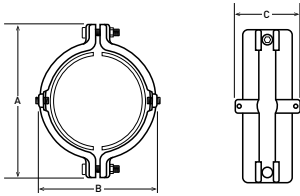
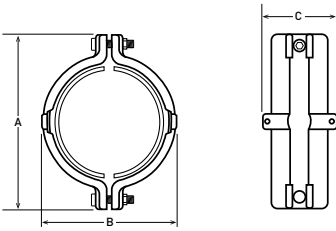
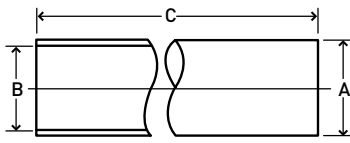

Supplied with grub screws for continuity.

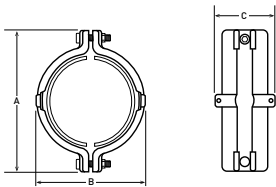
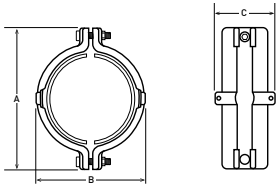

DOUBLE SPIGOT PIPES

Product Code	Diameter (mm)	Max. Overall Dia. A (mm)	Min. Internal Dia. B (mm)	Length C (mm)	Nominal Weight (kg)
MS2001	50	60	47.50	3000	15.7
MS3001	70	80	68.25	3000	19.4
MS4001	100	112	97.50	3000	29.7
MS6001	150	162	146.25	3000	45.2

DUCTILE IRON COUPLINGS

Product Code	Diameter (mm)	A (mm)	B (mm)	C (mm)	Nominal Weight (kg)
MS2012	50	117	79	69	0.7
MS3012	70	137	100	73	0.8
MS4012	100	172	132	73	1.1
MS6012	150	223	180	95	2.0

DUCTILE IRON COUPLINGS WITH CONTINUITY

Product Code	Diameter (mm)	A (mm)	B (mm)	C (mm)	Nominal Weight (kg)
MS2012C	50	117	79	69	0.7
MS3012C	70	137	100	73	0.8
MS4012C	100	172	132	73	1.1
MS6012C	150	223	180	95	2.0

CONVERSION COUPLING - MECH 416 TO LCC SOIL

Product Code	Mech 416 Diameter (mm)	LCC Diameter (mm)	A (mm)	B (mm)	C (mm)	Nominal Weight (kg)
MS3018	70	65	137	100	73	0.9
MS4017	100	100	172	132	73	1.2

CONVERSION COUPLING - MECH 416 TO ALTERNATIVELY SIZED EQUIVALENT SYSTEMS

Product Code	Mech 416 Diameter (mm)	Alternative Diameter (mm)	A (mm)	B (mm)	C (mm)	Nominal Weight (kg)
MS3019	70	75	142	105	73	1.0

bends

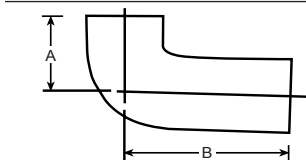
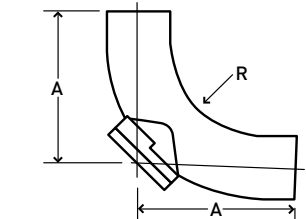
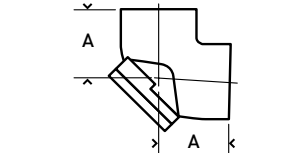
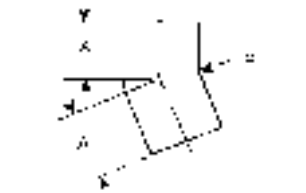
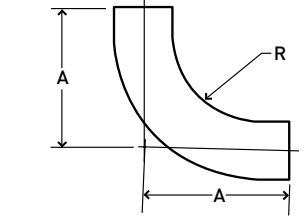
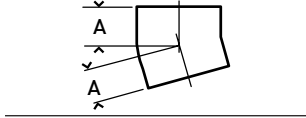
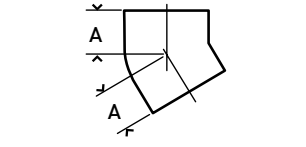
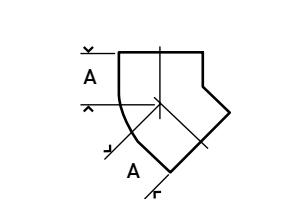
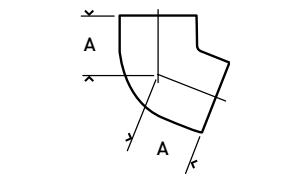
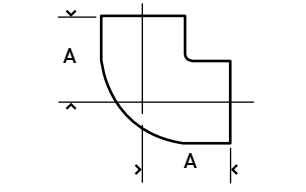

87.5° SHORT RADIUS BENDS				
Product Code	Diameter (mm)	A (mm)	Nominal Weight (kg)	
MS2003	50	75	0.8	
MS3003	70	90	1.3	
MS4003M	100	145	3.0	
MS6003	150	145	5.1	
67.5° SHORT RADIUS BENDS				
Product Code	Diameter (mm)	A (mm)	Nominal Weight (kg)	
MS4004M	100	135	3.0	
45° SHORT RADIUS BENDS				
Product Code	Diameter (mm)	A (mm)	Nominal Weight (kg)	
MS2005	50	50	0.6	
MS3005	70	60	0.9	
MS4005M	100	135	2.7	
MS6005	150	90	3.6	
30° SHORT RADIUS BENDS				
Product Code	Diameter (mm)	A (mm)	Nominal Weight (kg)	
MS4006	100	60	1.4	
15° SHORT RADIUS BENDS				
Product Code	Diameter (mm)	A (mm)	Nominal Weight (kg)	
MS4007	100	50	1.2	
87.5° LONG RADIUS BENDS				
Product Code	Diameter (mm)	A (mm)	R (mm)	Nominal Weight (kg)
MS4008	100	269	180	5.3
MS6008	150	274	150	10.7
22.5° LONG RADIUS BENDS				
Product Code	Diameter (mm)	A (mm)	R (mm)	Nominal Weight (kg)
MS4009	100	90	180	2.2
87.5° SHORT RADIUS BENDS WITH DOOR				
Product Code	Diameter (mm)	A (mm)	Nominal Weight (kg)	
MS3010	70	90	2.1	
MS4010M	100	145	4.1	
87.5° LONG RADIUS BENDS WITH DOOR				
Product Code	Diameter (mm)	A (mm)	R (mm)	Nominal Weight (kg)
MS4011	100	269	125	7.3
MS6011	150	274	150	12.7
87.5° LONG TAIL BEND				
Product Code	Diameter (mm)	A (mm)	R (mm)	Nominal Weight (kg)
MS4013	100	110	250	4.0

branches

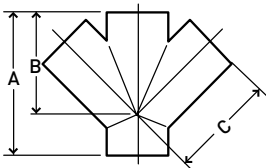
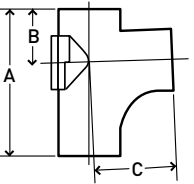
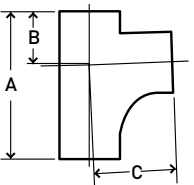
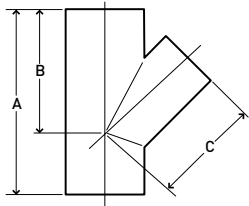
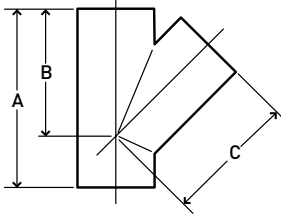
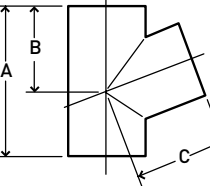
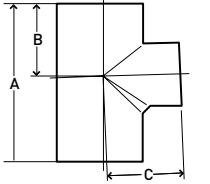
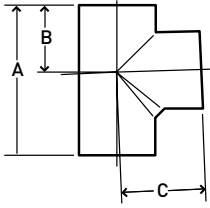

87.5° SINGLE EQUAL BRANCHES

Product Code	Diameter (mm)	A (mm)	B (mm)	C (mm)	Nominal Weight (kg)
MS2020	50 x 50	145	66	80	1.1
MS3021	70 x 70	180	83	95	1.8

87.5° SINGLE UNEQUAL BRANCHES

Product Code	Diameter (mm)	A (mm)	B (mm)	C (mm)	Nominal Weight (kg)
MS3020	70 x 50	155	72	90	1.5
MS4020	100 x 50	170	76	105	2.2
MS4021	100 x 70	190	88	110	2.5

67.5° SINGLE EQUAL BRANCHES

Product Code	Diameter (mm)	A (mm)	B (mm)	C (mm)	Nominal Weight (kg)
MS4025	100 x 100	215	130	130	3.4

45° SINGLE EQUAL BRANCHES

Product Code	Diameter (mm)	A (mm)	B (mm)	C (mm)	Nominal Weight (kg)
MS2026	50 x 50	160	115	120	1.3
MS3027	70 x 70	200	145	150	2.2
MS4028	100 x 100	260	190	190	4.3
MS6027	150 x 150	355	265	265	10.5

45° SINGLE UNEQUAL BRANCHES

Product Code	Diameter (mm)	A (mm)	B (mm)	C (mm)	Nominal Weight (kg)
MS3026	70 x 50	170	130	130	1.8
MS4026	100 x 50	180	150	150	2.4
MS4027	100 x 70	215	170	170	3.1
MS6026	150 x 100	280	225	225	5.8

87.5° SINGLE RADIUS CURVE BRANCHES

Product Code	Diameter (mm)	A (mm)	B (mm)	C (mm)	Nominal Weight (kg)
MS4030	100 x 100	260	102	150	4.1
MS6030	150 x 100	375	115	202	6.5
MS6031	150 x 150	400	135	260	11.7

87.5° SINGLE RADIUS CURVE BRANCHES WITH DOOR

Product Code	Diameter (mm)	A (mm)	B (mm)	C (mm)	Nominal Weight (kg)
MS4032	100 x 100	270	102	150	5.4
MS6032	150 x 100	300	115	202	9.5
MS6033	150 x 150	400	140	260	14.2

45° DOUBLE BRANCHES

Product Code	Diameter (mm)	A (mm)	B (mm)	C (mm)	Nominal Weight (kg)
MS4036	100 x 100	260	190	190	5.7
MS6036	150 x 100	280	225	225	6.5

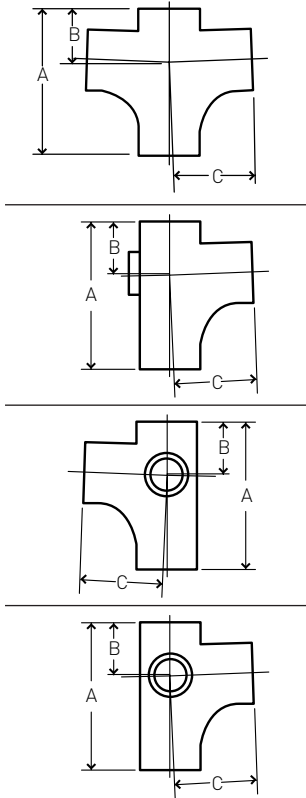

87.5° DOUBLE RADIUS CURVE BRANCHES					
Product Code	Diameter (mm)	A (mm)	B (mm)	C (mm)	Nominal Weight (kg)
MS4038	100 x 100	270	102	150	5.3
MS6038	150 x 100	300	115	200	8.2
87.5° SINGLE RADIUS CURVE BRANCH WITH 2" BSPT BOSS ON BACK					
Product Code	Diameter (mm)	A (mm)	B (mm)	C (mm)	Nominal Weight (kg)
MS4039B	100 x 100	260	102	150	4.1
87.5° SINGLE RADIUS CURVE BRANCH WITH 2" BSPT BOSS ON LEFT					
Product Code	Diameter (mm)	A (mm)	B (mm)	C (mm)	Nominal Weight (kg)
MS4039L	100 x 100	260	102	150	4.1
87.5° SINGLE RADIUS CURVE BRANCH WITH 2" BSPT BOSS ON RIGHT					
Product Code	Diameter (mm)	A (mm)	B (mm)	C (mm)	Nominal Weight (kg)
MS4039R	100 x 100	260	102	150	4.1



fittings

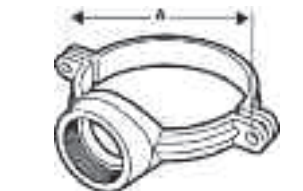
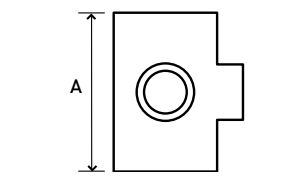
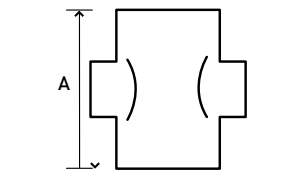
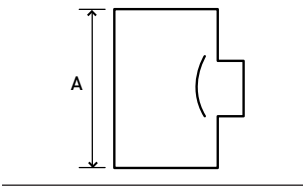
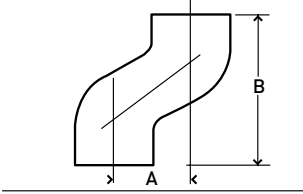
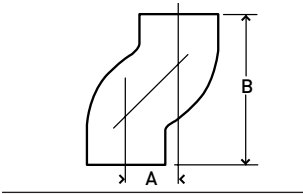
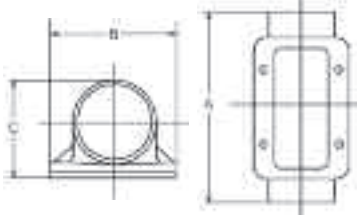
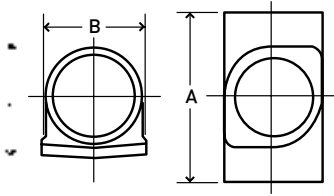

ACCESS PIPES WITH ROUND DOOR

Product Code	Diameter (mm)	A (mm)	B (mm)	C (mm)	Nominal Weight (kg)
MS2043	50	170	80	76	1.7
MS3043	70	205	98	92	2.5
MS4043	100	250	118	130	4.3
MS6043	150	280	172	180	7.9

ACCESS PIPES WITH RECTANGULAR DOOR

Product Code	Diameter (mm)	A (mm)	B (mm)	C (mm)	Nominal Weight (kg)
MS4049	100	320	160	129	8.0
MS6049	150	395	215	184	13.5

OFFSETS 75MM PROJECTION

Product Code	Diameter (mm)	A (mm)	B (mm)	Nominal Weight (kg)
MS4044	100	75	215	2.6

OFFSETS 130MM PROJECTION

Product Code	Diameter (mm)	A (mm)	B (mm)	Nominal Weight (kg)
MS2045	50	130	230	1.4
MS3045	70	130	250	2.3
MS4045	100	130	270	3.8

BOSS PIPES SINGLE 2" BSPT

Product Code	Diameter (mm)	A (mm)	Nominal Weight (kg)
MS3053	70	148	1.6
MS4053	100	155	2.1
MS6053	150	175	3.6

BOSS PIPES DOUBLE 2X2" BSPT OPPOSED

Product Code	Diameter (mm)	A (mm)	Nominal Weight (kg)
MS4054	100	155	2.2

BOSS PIPES DOUBLE 2X2" BSPT AT 90°

Product Code	Diameter (mm)	A (mm)	Nominal Weight (kg)
MS4055	100	155	2.2

STRAP ON BOSS 2" BSPT

Product Code	Diameter (mm)	Nominal Weight (kg)
MS4092	100	2.0

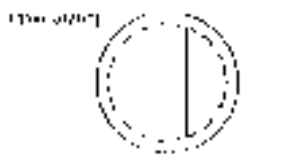
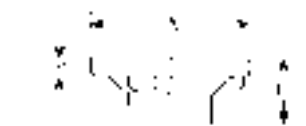
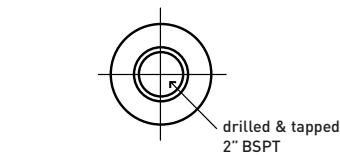
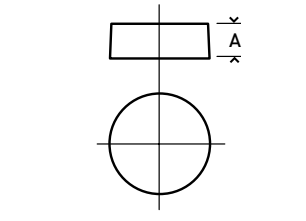
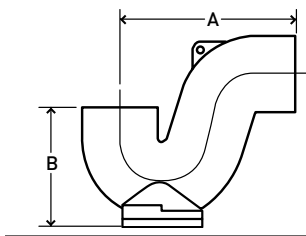
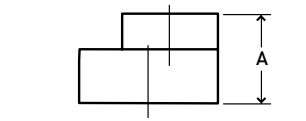

PIPE TAPERS

Product Code	Diameter (mm)	A (mm)	Nominal Weight (kg)
MS3046	70 x 50	78	0.6
MS4046	100 x 50	80	0.9
MS4047	100 x 70	88	1.1
MS6048	150 x 100	102	2.4

P TRAPS WITH BOTTOM DOOR

Product Code	Diameter (mm)	A (mm)	B (mm)	Nominal Weight (kg)
MS2050	50	160	115	2.3
MS3050	70	200	140	3.6
MS4050	100	255	175	6.8
MS6050	150	350	245	15.8

BLANK ENDS

Product Code	Diameter (mm)	A (mm)	Nominal Weight (kg)
MS2051	50	30	0.2
MS3051	70	35	0.4
MS4051	100	40	0.8
MS6051	150	50	1.6

BLANK ENDS DRILLED & TAPPED 2"

Product Code	Diameter (mm)	A (mm)	Nominal Weight (kg)
MS4052	100	40	0.7
MS6052	150	50	1.5

BELLMOUTH GULLY INLET

Product Code	Diameter (mm)	A (mm)	B (mm)	C (mm)	Nominal Weight (kg)
MS4070	100	215	25	85	2.9

SOLID COVER WITH RUBBER SEAL & SCREWS

Product Code	Diameter (mm)	Nominal Weight (kg)
MS8076	200	2.2

PLAIN GRATING TO SUIT MS4070

Product Code	Diameter (mm)	Nominal Weight (kg)
MS8077	200	1.8

BOLT ON PUDDLE FLANGE

Product Code	Diameter (mm)	A (mm)	B (mm)	C (mm)	Nominal Weight (kg)
MS4078	100	220	12	50	4.0

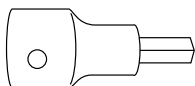
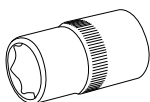
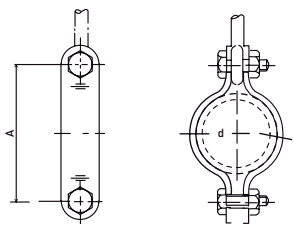
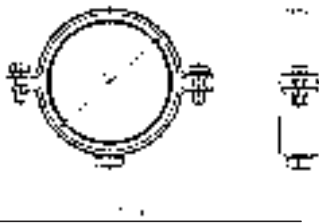
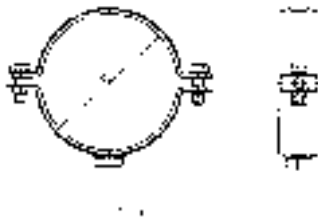

COATED ADJUSTABLE BRACKETS

Product Code	Diameter (mm)	Nominal Weight (kg)
MS2067	50	0.3
MS3067	70	0.3
MS4067	100	0.6 (Steel)
MS6067	150	0.8 (Steel)

ZINC PLATED RUBBER LINED BISMAT BRACKETS

Product Code	Diameter (mm)	G
HS2061	50	M8/ M10
HS3061	70	M8/ M10
HS4061	100	M8/ M10
HS6061	150	M10

ZINC PLATED HEAVY DUTY BOSSED BRACKETS

Product Code	Diameter (mm)	G
HS2063	50	M8/ M10
HS3063	70	M10/ M12
HS4063	100	M10/ M12
HS6063	150	M10/ M12

ZINC PLATED RUBBER LINED HEAVY DUTY BOSSED BRACKETS

Product Code	Diameter (mm)	G
HS2064	50	M8/ M10
HS3064	70	M10/ M12
HS4064	100	M10/ M12
HS6064	150	M10/ M12

GALVANISED PIPE CLAMPS

Product Code	Diameter (mm)	G
HS2062	50	M10
HS3062	70	M10
HS4062	100	M10
HS6062	150	M10

ZINC PLATED SPLIT BAND CLIPS

Product Code	Diameter (mm)	A (mm)
HS2065	50	114
HS3065	70	116
HS4065	100	176
HS6065	150	226

RATCHET SPANNER

Product Code	
HSD001	1/2" Drive

SOCKET (FOR ACCESS DOOR BOLTS)

Product Code	Diameter (mm)
HSD002	13

ALLEN SOCKET ADAPTER (FOR COUPLINGS)

Product Code	Diameter (mm)
HSD003	6



Hargreaves

RAINWATER • SOIL • DRAINAGE

Hargreaves Drainage Water Lane South Parade Halifax West Yorkshire HX3 9HG

Telephone: 01422 330607 Fax: 01422 320349 E-Mail: info@hargreavesfoundry.co.uk www.hargreavesdrainage.com